

CONTEMPO



SUSTAINABILITY
2018

CONTEMPO



SUSTAINABLE BUSINESS PRACTICES



SUSTAINABLE BUSINESS PRACTICES

RECYCLING

Paper and cardboard used throughout the office are recycled throughout the office.

This means less waste leaves the building and goes to the landfill.





SUSTAINABLE BUSINESS PRACTICES

RECYCLING

PET plastic used to make cards in the USA is a more sustainable plastic than other plastics. It is a safer option that does not off-gas.

All scrap material from the factory is recycled by being reground post-production.

The reground plastic is used to make new plastic at Contempo USA.

This means less waste leaves the building and goes to the landfill.





SUSTAINABLE BUSINESS PRACTICES

ENERGY

Lighting throughout the building uses energy efficient LED bulbs.

This saves energy and cost to replace bulbs.

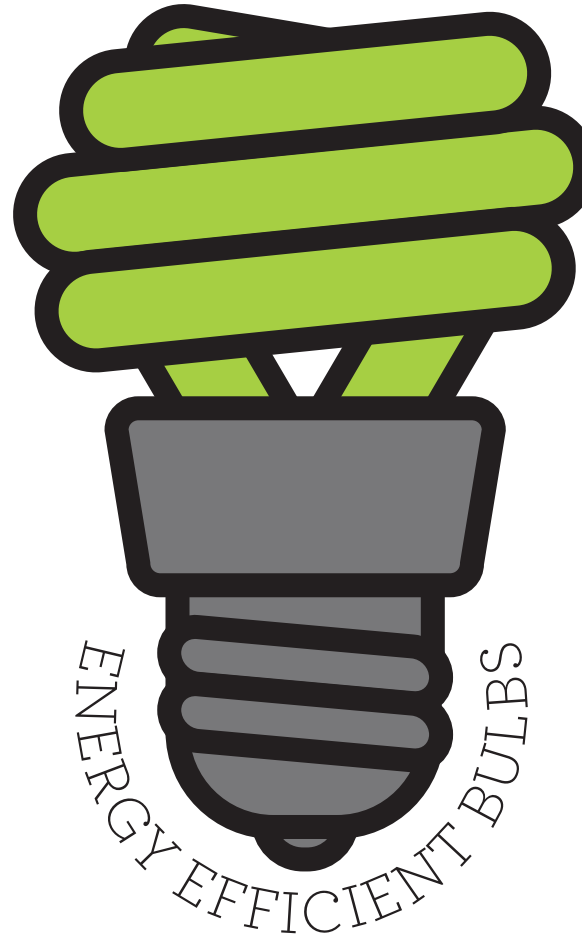

CONTEMPO



SUSTAINABLE BUSINESS PRACTICES

MATERIAL

FSC certified paper board is used for all USA production.



FSC

100%

From well-managed forests

CONTEMPO



PACKAGING RECYCLABILITY



PACKAGING RECYCLABILITY

MOD SOLUTIONS

RECYCLING

All board cards are recyclable by the consumer at home.

Components must be put in the trash and end up in the landfill.

CONSUMER STEPS:

1. Separate components.

2. Paper

Plastic

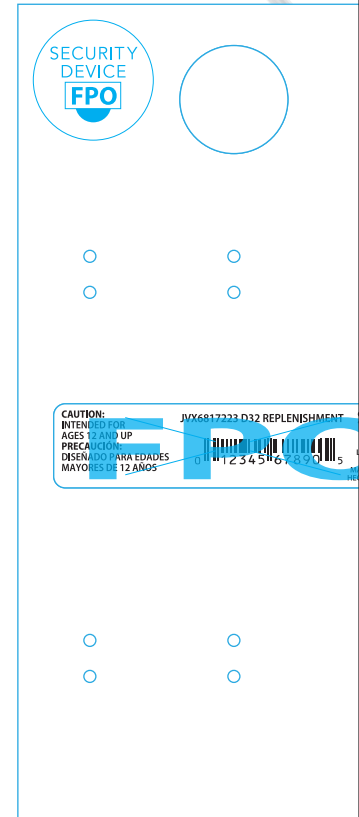
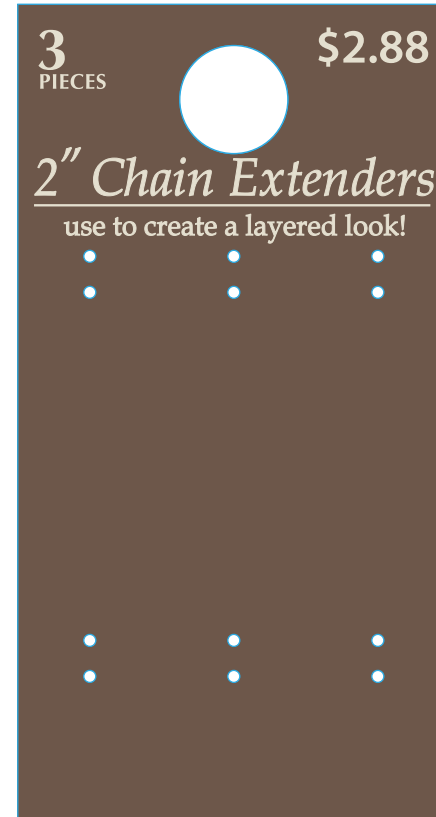

S.X.P-287274C
2" CHAIN EXTENDER CARD
2.250" X 4.250"



PACKAGING RECYCLABILITY

MOD SOLUTIONS

RECYCLING

Foldovers with full coverage adhesive have a lower chance of being recycled.

Vacuum formed plastic is recycled as long as it is separated from the board.

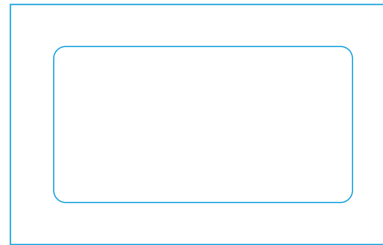

CONSUMER STEPS:

1. Separate components.

2. Paper

Plastic



K.I.T-702978C

KIT INCLUDES:

S.F.P-287276C
FOLDOVER
2.3125" X 6.00"

O.X.N-660312C
BLISTER
2.00" X 1.25" X .625"

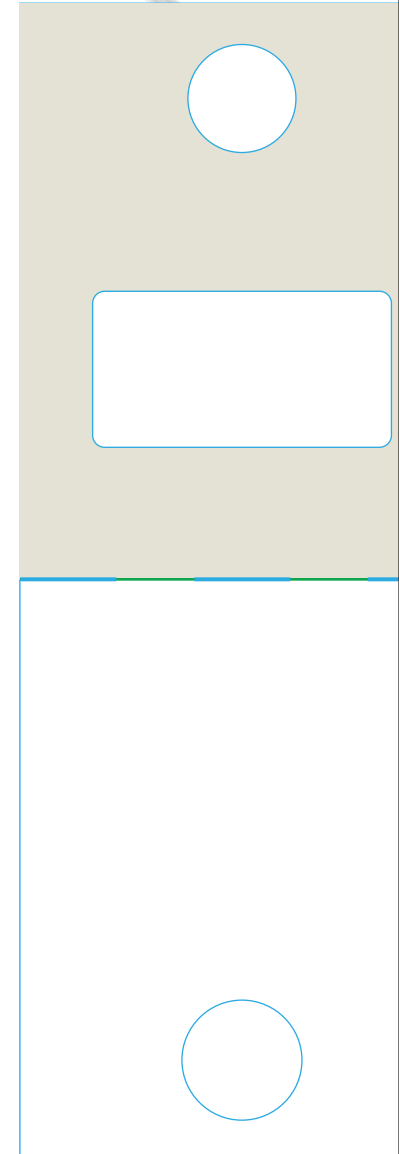
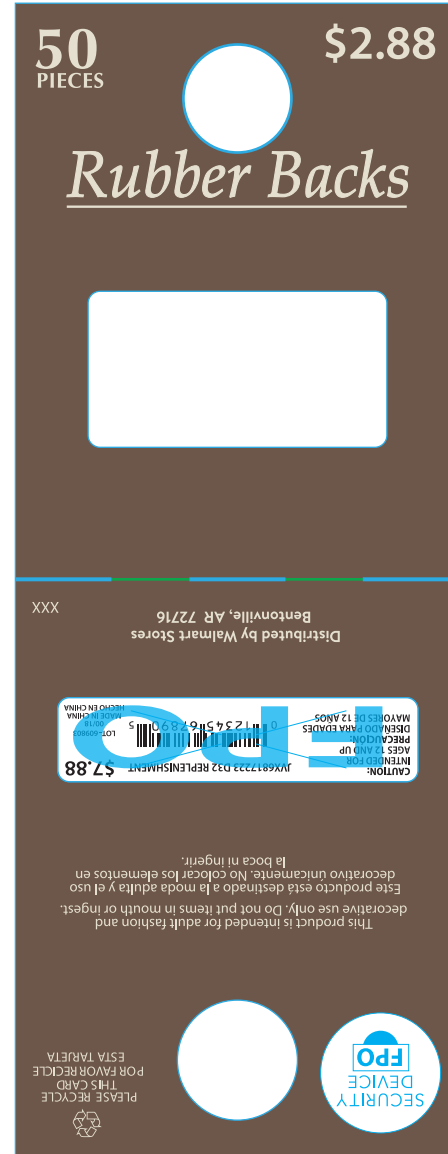



PACKAGING RECYCLABILITY

MOD SOLUTIONS

RECYCLING

Foldovers with partial adhesive have a good chance of being recycled.



CONSUMER STEPS:

1. Recycle.

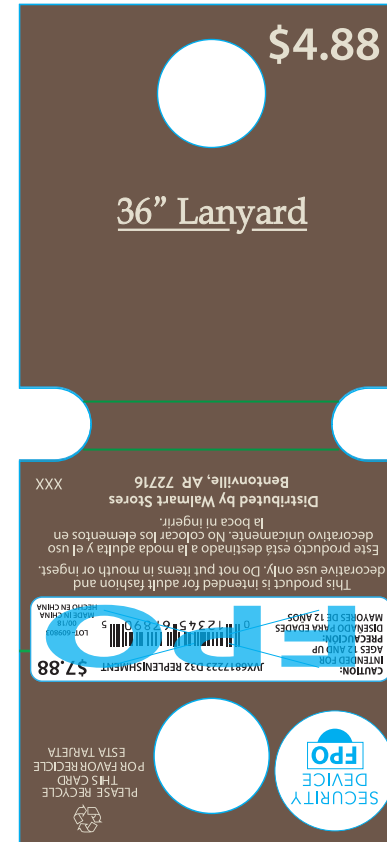

S.F.P-287310C
36" LANYARD FOLDOVER
2.000" X 4.375"

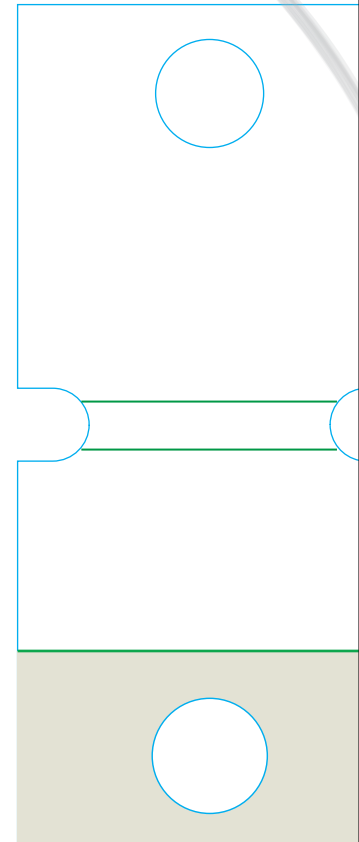

CONTEMPO



PACKAGING RECYCLABILITY

NO BOUNDARIES

RECYCLING

All board cards are recyclable by the consumer at home.

Components must be put in the trash and end up in the landfill.

CONSUMER STEPS:

1. Separate components.
2. Paper Plastic

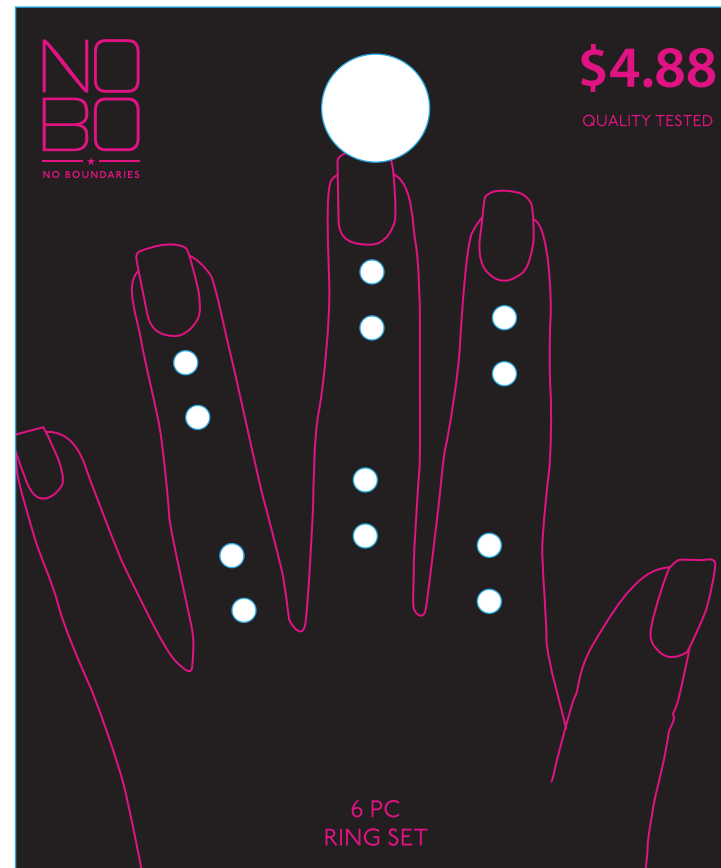

S.R.P-287387C
6 ON RING CARD
3.750" X 4.500"





PACKAGING RECYCLABILITY

NO BOUNDARIES

RECYCLING

Foldovers with partial adhesive have a good chance of being recycled.



CONSUMER STEPS:

1. Paper

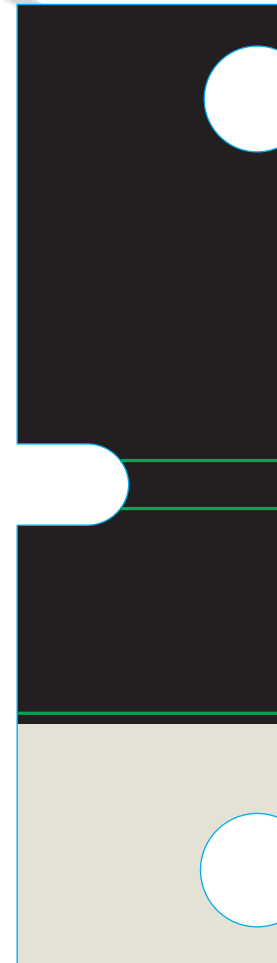
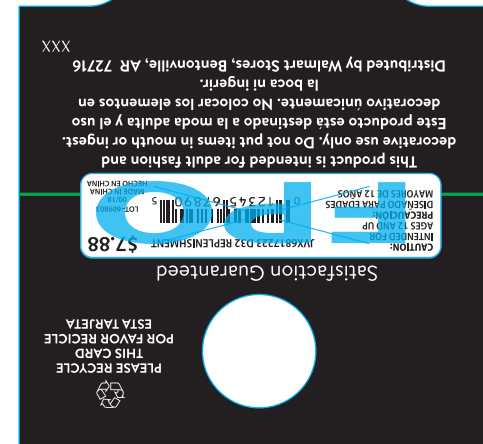
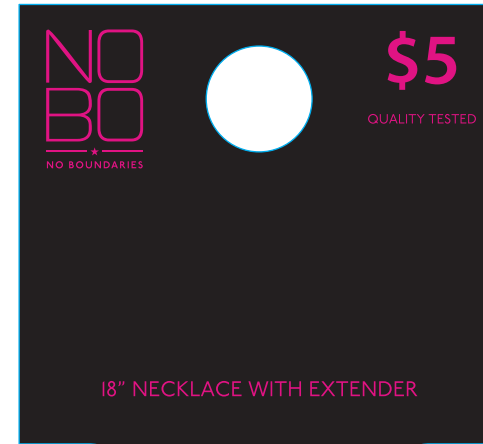

**S.F.P-287390C
FOLDOVER
2.500" X 5.000"**

CONTEMPO



PACKAGING RECYCLABILITY

NO BOUNDARIES

RECYCLING

All board cards are recyclable by the consumer at home.

Polycapping is minimal and should not impede recyclability.

CONSUMER STEPS:

1. Paper

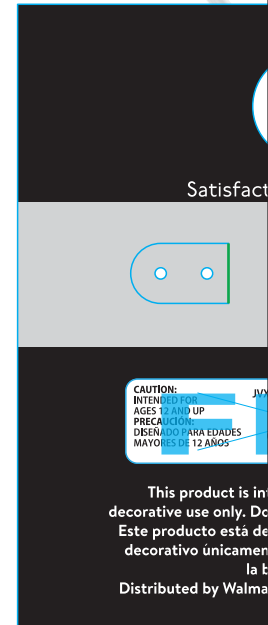

**S.E.P-287381C
EARRING CARD
3.000" X 3.250"**



PACKAGING RECYCLABILITY

wonder
nation..

RECYCLING

All board cards are recyclable by the consumer at home.

Components must be put in the trash and end up in the landfill.

CONSUMER STEPS:

1. Paper

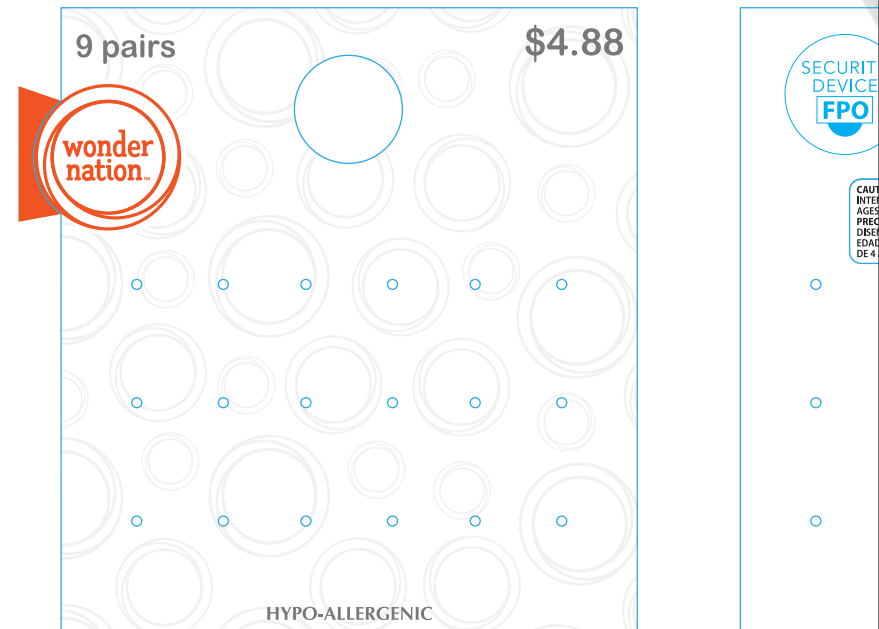

S.M.P-287024C
9 PAIRS EARRING CARD
3.140" X 3.250"



PACKAGING RECYCLABILITY

wonder nation.

RECYCLING

Foldovers with partial adhesive have a good chance of being recycled.



CONSUMER STEPS:

1. Paper

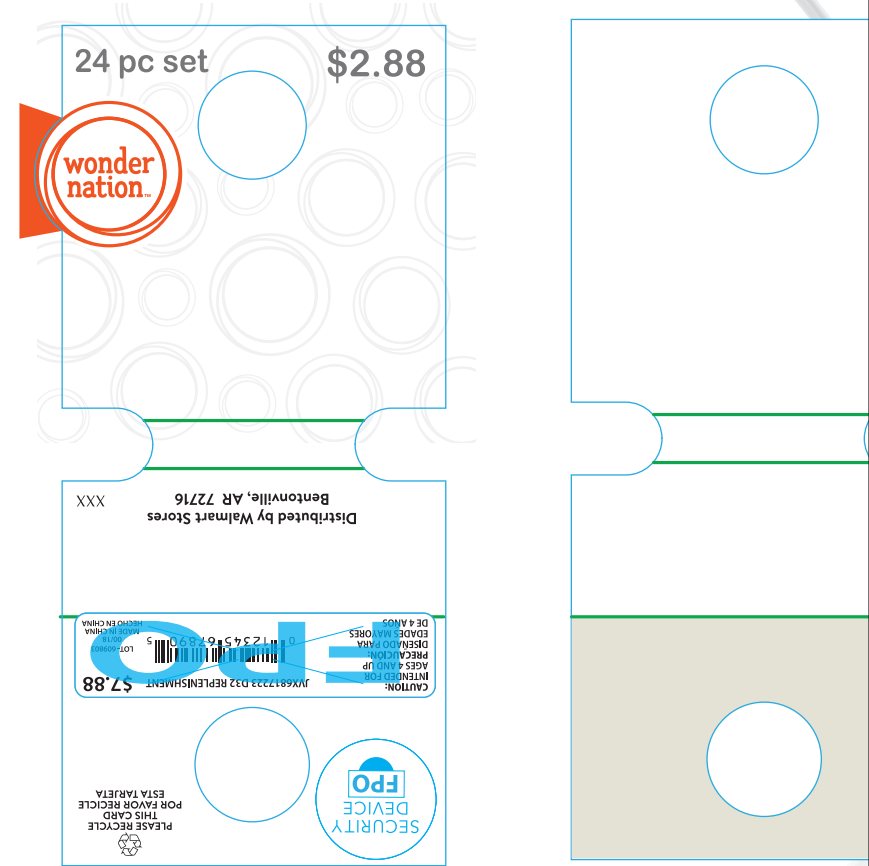

**S.F.P-287243C
FOLDOVER
2.140" X 4.375"**



PACKAGING RECYCLABILITY

DISPLAYS

RECYCLING

All board displays are recyclable and made from recycled paper.

Components just need to be flattened and placed in the recycling bin!



CONSUMER STEPS:

1. Paper





Want to increase the chances of your packaging being recycled?

How2Recycle

www.how2recycle.info

The How2Recycle Label program is designed to “reduce confusion by creating a clear, well-understood, and nationally harmonized label that enables companies to convey to consumers how to recycle a package. Improve the reliability, completeness, and transparency of recyclability claims. Provide a labeling system that follows Federal Trade Commission Green Guides. Increase the availability and quality of recycled material.”



Preparing Material for Recycling

Information is provided to ensure the proper steps are taken to effectively recycle materials.

How2Recycle

Information and locational instructions let you know if an item can be recycled traditionally or by other means.

Type of Recyclable Material

Lists what type of material the packaging is made from.

Lists Recyclable Parts of Packaging

Information on what parts of the packaging needs to be recycled in this specific way.



PACKAGING RECYCLABILITY

Why join?



Benefits of Joining



CONTEMPO



MATERIAL SUSTAINABILITY



MATERIAL SUSTAINABILITY

MOD SOLUTIONS

MATERIALS

SUBSTRATE:

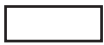

.028" CCNB



Recycled content, recyclable

LAMINATE:



BRONZE EMBOSSED
MILLED PAPER - MATCH SAMPLE



Added lamination process
IMPROVE BY:
Print direct to substrate

FOIL FRONT:



MATTE CREAM -
MATCH SAMPLE



Waste produced by foil
IMPROVE BY:
Print direct to substrate

INK BACK:



BLACK



S.M.P-287291C

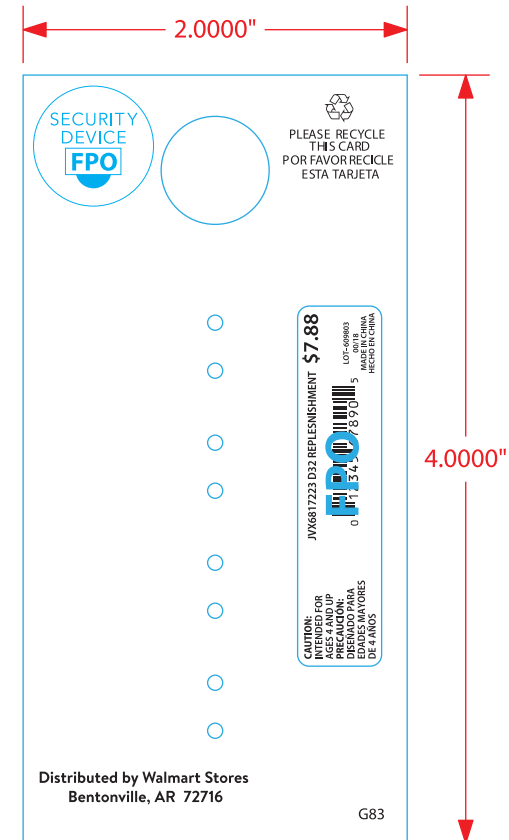



MATERIAL SUSTAINABILITY

NO BOUNDARIES

MATERIALS

SUBSTRATE:



FSC certified board, recyclable

FOIL:



PINK

Waste produced by foil
 IMPROVE BY:
 Print direct to substrate

INK:



BLACK

IMPROVE BY:
 Minimizing ink usage, i.e. remove black background from back of card

OTHER:

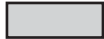

0.75" x 2.875"
 POLYCAP ON BACK



Added plastic material becomes waste
 IMPROVE BY:
 Removing, use post holes that sit at the bottom of the card, product will hang off



S.E.P-287141C

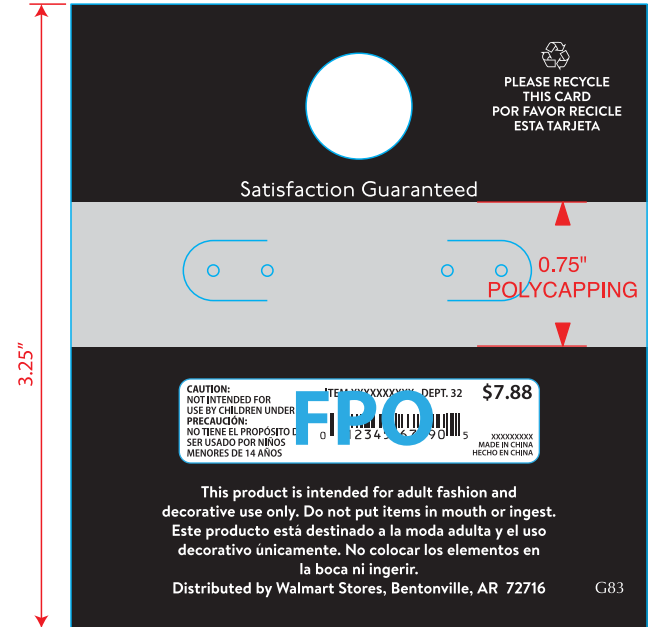

3.000"

3.25"



MATERIAL SUSTAINABILITY

wonder nation

MATERIALS

SUBSTRATE:



FSC certified board, recyclable

INK FRONT:



PMS ORANGE 021



PMS COOL GRAY 9C 10% AND 100%



BLACK

COATING:



NON-SCRATCH MATTE



SPOT UV



SPOT VARNISH PER SAMPLE



Added processes
IMPROVE BY:
Keep to a minimum

ADHESIVE:



1.500" WINGTAI DS-11-2



Added plastic material becomes waste
IMPROVE BY:
Keep to a minimum or use a flat card

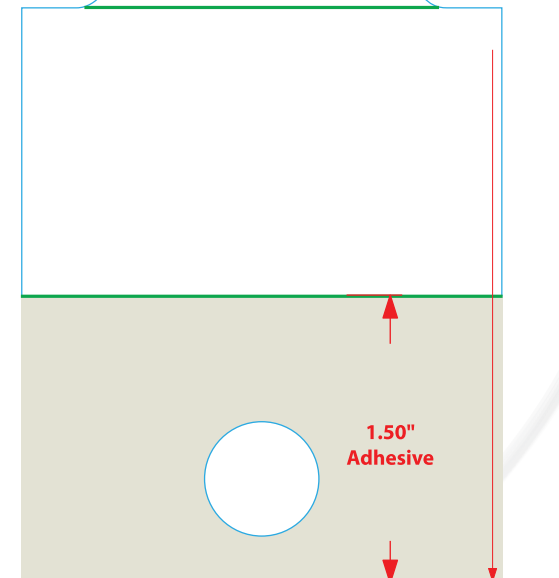
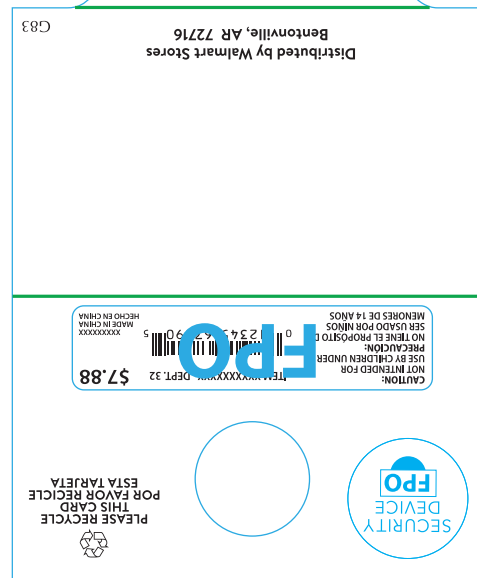
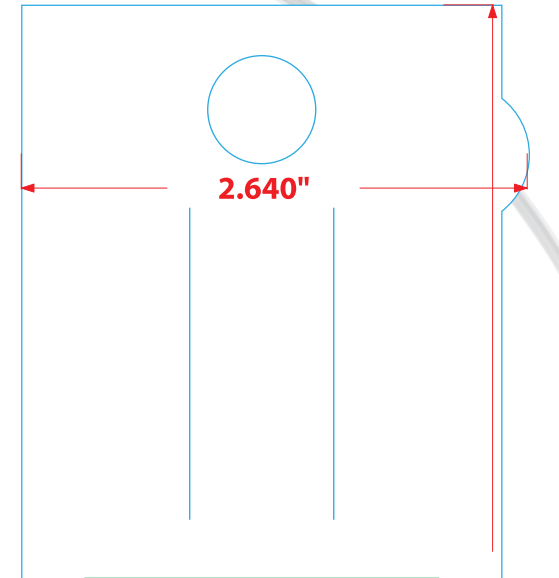
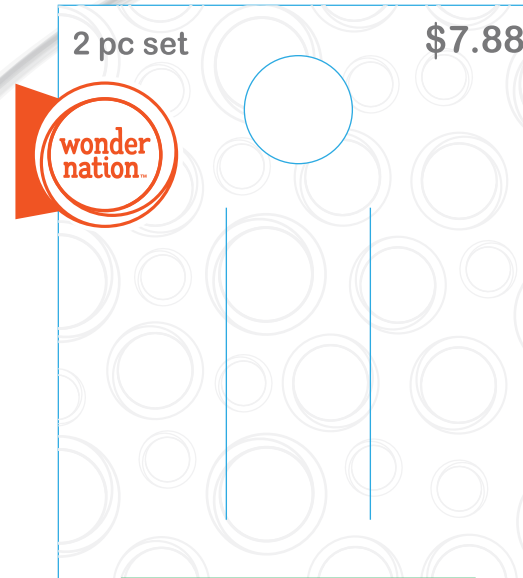

S.F.P-287026C



MATERIAL SUSTAINABILITY

Sustainable Material Alternatives

KONA PAPER

Paper made from recycled coffeebean bags

HEMP-BLENDED PAPER

Paper mixed with hemp fibers

SEED PAPER

Paper embedded with seeds for planting





MATERIAL SUSTAINABILITY

Sustainable Material Alternatives

PLA PLASTIC

A corn-based plastic

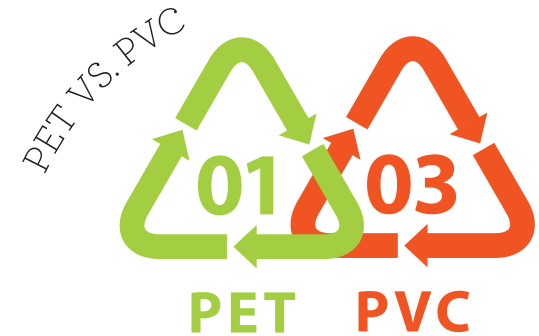

PET PLASTIC

Replacing PVC plastics with PET is a safer plastic for people and the environment

MOLDED PAPER PULP

MOLDED PAPER PULP

3D forms made with molded paper pulp reduces added materials and labor





PRODUCT PROTECTION

ANTI-TARNISH SOLUTIONS

LOW SULPHUR MATERIALS

Use materials that have low sulphur content to prevent tarnishing

SULPHUR ABSORBING COATING

Use a coating to absorb the sulphur away from the jewelry

Apply to the inside of a box, or to the back of inserts/cards

SILICA PACKET

Use a silica packet in boxes

SILICA PACKET



SULPHUR ABSORBING COATING

